

# DJI Smart Controller

User Manual v1.2

2019.04

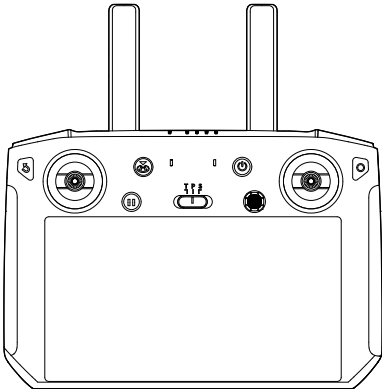

### **Searching for Keywords**

Search for keywords such as “battery” and “install” to find a topic. If you are using Adobe Acrobat Reader to read this document, press Ctrl+F on Windows or Command+F on Mac to begin a search.

### **Navigating to a Topic**

View a complete list of topics in the table of contents. Click on a topic to navigate to that section.

### **Printing this Document**

This document supports high resolution printing.

# Using this Manual

## Legends

⚠ Warning

⚠ Important

💡 Hints and Tips

📖 Explanation

## Video Tutorials

Please watch the tutorial videos in the link below, which demonstrate how to use this product safely:  
<https://www.dji.com/smart-controller?site=brandsite&from=nav>

## Download DJI™ ASSISTANT™ 2

Download DJI Assistant 2 at <http://www.dji.com/dji-smart-controller>



# Contents

Using this Manual	1
Legends	1
Video Tutorials	1
Download DJITM ASSISTANT™ 2	1
Contents	2
Product Profile	3
Introduction	3
Overview	4
Preparing the Smart Controller	6
Charging the Battery	6
Attaching the Control Sticks	6
Smart Controller Operations	7
Turning the Smart Controller On and Off	7
Activating the Smart Controller	7
Linking the Smart Controller	8
Controlling the Aircraft	8
Operating the Camera	12
Dual Remote Controller Mode	13
Display Interface	14
Homepage	14
Quick Settings	15
DJI GO 4 App / DJI Pilot	16
Appendix	17
Changing Storage Locations for Images and Videos	17
Control Stick Navigation	17
DJI GO Share (only available when using DJI GO 4)	17
Status LED and Battery Level Indicators Description	18
Smart Controller Warning Sounds	19
System Update	19
Button Combinations	19
Calibrating the Compass	20
Blocking Third-party Notifications	21
HDMI	21
After-sales Information	21
Specifications	22

# Product Profile

## Introduction

The DJI Smart Controller features OCUSYNC™ 2.0 technology and is compatible with aircraft which support OcuSync 2.0. With a wide range of function buttons, the remote controller can perform a variety of tasks and control the aircraft within a maximum range of 8 km. Dual transmission frequency support makes HD video downlink stable and reliable.

**Ultra-bright Screen:** The built-in 5.5 inch screen boasts a high brightness of 1000 cd/m<sup>2</sup> and a resolution of 1920x1080 pixels.

**Multiple Connections:** The Smart Controller supports Wi-Fi and Bluetooth connections.

**Video and Audio Management:** The Smart Controller has a built-in microphone and speaker, and is capable of displaying 4K videos at 60 fps both in H.264 and H.265 formats. In addition, the videos can be displayed on an external monitor by using the HDMI port.

**Extended Storage Capability:** The Smart Controller's storage capability can be increased by using a microSD card. This allows users to store more images and videos and makes it easier to export them to a computer.

**Reliable in More Environments:** The Smart Controller can operate normally within a wide temperature range from -4° F (20° C) to 104° F (40° C).

**Compatible with More DJI Aircrafts:** With the Aircraft Management feature of Smart Controller, users can add and manage more aircraft models. The Mavic 2 Pro, Mavic 2 Zoom, and Mavic 2 Enterprise series are supported.

**DJI GO Share:** The brand new DJI GO Share function of the built-in DJI GO 4 App enable users to transfer images and videos to smart devices after they have been downloaded from playback in DJI GO™ 4.



- Maximum flight time was tested in windless conditions at a consistent speed of 15.5 mph (25 kph) using the MAVIC™ 2. This value should be taken for reference only.
  - Refer to Specifications to check compatible aircrafts models.
  - To comply with local regulations, the 5.8 GHz frequency is not available in some countries and regions.
  - 4K/60fps is supported for non HDR 10 bit videos. When selecting HDR 10 bit videos, only 4k/30fps is available.
  - The main difference between linking the Smart Controller with the Mavic 2 Pro/Zoom and the Smart Controller with the Mavic 2 Enterprise series, is the built-in app used for flight. The Mavic 2 Pro/Zoom uses the DJI GO 4 app and the Mavic 2 Enterprise series uses DJI Pilot. The general descriptions in this manual apply to all aircraft models that link to the Smart Controller.
-

## Overview

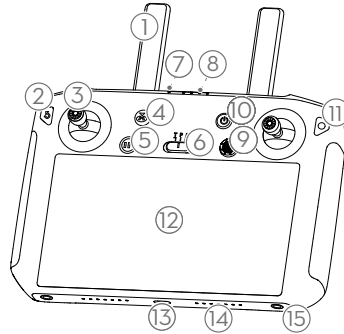

### 1 Antennas

Relays aircraft control and video signal.

### 2 Back Button / Function Button

Press once to return to the previous page and press twice to go back to the homepage. Hold to view a guide to using button combinations. Refer to the Button Combinations section for more information.

### 3 Control Sticks

Control the orientation and movement of the aircraft when the remote controller is linked to an aircraft. Go to Settings > Control Stick Navigation, to customize the navigation settings.

### 4 RTH Button

Press and hold to initiate Return to Home (RTH). Press again to cancel RTH.

### 5 Flight Pause Button

Press once to exit TapFly, ActiveTrack, and other Intelligent Flight Modes.

### 6 Flight Mode Switch

Switch between T-mode, P-mode, and S-mode.

### 7 Status LED

Indicates the linking status and warnings for the control sticks, low battery level, and high temperature.

### 8 Battery Level LEDs

Displays the battery level of the remote controller.

### 9 5D Button

The default configuration is listed below. The functions can be set in DJI GO 4 / DJI Pilot.

Up: Recenter gimbal/move gimbal downward

Down: Focus switch/metering

Left: Decrease EV value

Right: Increase EV value

Press: Open DJI GO 4 / DJI Pilot Intelligent Flight Modes menu (not available for Mavic 2 Enterprise series).

When the remote controller is not linked to an aircraft, the 5D button can be used to navigate on the remote controller. Go to Settings > Control Stick Navigation to enable this function.

### 10 Power Button

Use to turn the remote controller on and off.

When the remote controller is powered on, press the button to enter sleep mode or to wake up the controller.

### 11 Confirm Button / Customizable Button C3\*

When the remote controller is not linked to an aircraft, press to confirm a selection. When linked to an aircraft, the button cannot be used to confirm a selection. However, the function of the button when linked to an aircraft can be customized in DJI GO 4 / DJI Pilot.

\* This Confirm button can be customized in future firmware.

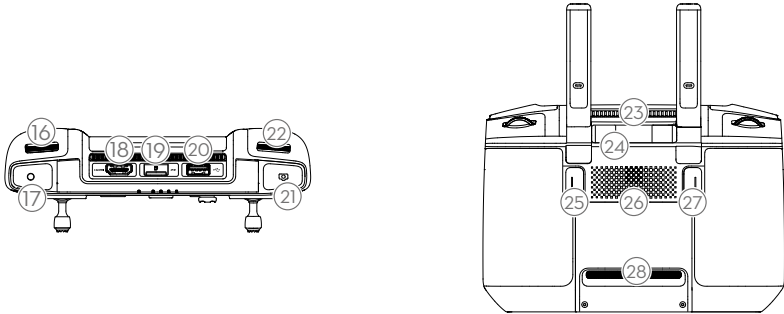
**12 Touchscreen**

Tap to select.

**13 USB-C Port**

Use to charge or update the remote controller.

**14 Microphone**

Records audio.

**15 Screw Holes****16 Gimbal Dial**

Use to control the camera's tilt.

**17 Record Button**

Press to start recording video. Press again to stop recording.

**18 HDMI Port**

For video output.

**19 microSD Card Slot**

Use to insert a microSD card.

**20 USB-A Port**

Use to connect external devices.

**21 Focus/Shutter Button**

Half press to focus, and then press to take a photo.

**22 Camera Settings Dial**

Mavic 2 Pro: Turn the dial to adjust the exposure compensation (when in Program mode), aperture (when in Aperture Priority and Manual mode), or shutter (when in Shutter Priority mode).

Mavic 2 Zoom/ Mavic 2 Enterprise: Turn to adjust the zoom of the Mavic 2 Zoom camera.

Mavic 2 Enterprise Dual: Turn the dial to adjust the exposure compensation.

**23 Air Vent**

Used for heat dissipation. DO NOT cover the air vent during use.

**24 Sticks Storage Slot**

Use to store a pair of control sticks.

**25 Customizable Button C2**

The default configuration is playback. The configuration can be set in DJI GO 4 / DJI Pilot.

**26 Speaker**

Outputs sound.

**27 Customizable Button C1**

The default configuration is center focus. The configuration can be set in DJI GO 4 / DJI Pilot.

**28 Air Intake**

Used for heat dissipation. DO NOT cover the air intake during use.

# Preparing the Smart Controller

## Charging the Battery

There are two pairs built-in 2500 mAh Li-ion batteries in the remote controller. Please charge the remote controller using the USB-C port.

Charging Time: 2 hours (using a standard USB power adapter)

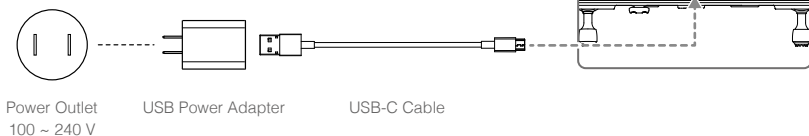

- ⚠ Please use a DJI official USB power adapter to charge the remote controller. If not, a USB power adapter certified FCC/CE rated 12 V/2 A is recommended.
- The battery will deplete when stored for an extended period of time. Please recharge the battery at least once every three months to prevent over discharging.

## Attaching the Control Sticks

Two pairs of control sticks are included in the packaging for the Smart Controller. One pair is stored in the sticks storage slot on the back of the remote controller. Follow the steps below to attach the control sticks stored in the sticks storage slot to the remote controller.

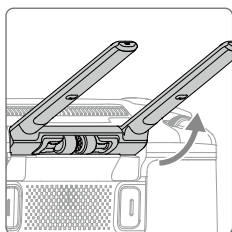

Lift the antennas

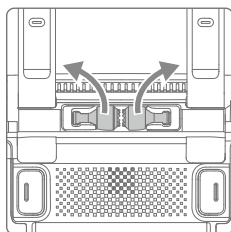

Remove the control sticks

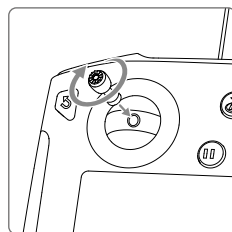

Rotate to attach the control sticks



# Smart Controller Operations

## Turning the Smart Controller On and Off

Follow the steps below to turn the remote controller on and off.

1. Press the power button once to check the current battery level. Charge the remote controller if the battery level is too low.
2. Hold the power button or press once and then hold the power button to power on the remote controller.
3. Repeat Step 2 to power off the remote controller.

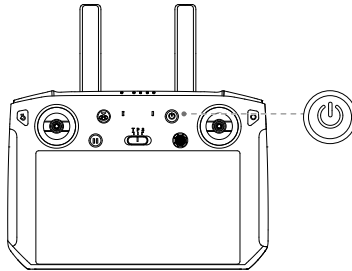

## Activating the Smart Controller



The Smart Controller needs to be activated before using for the first time. Make sure the remote controller can connect to the internet during activation. Follow the steps below to activate the Smart Controller.

1. Power on the remote controller. Select the language and tap "Next". Carefully read the terms of use and privacy policy and tap "Agree". After confirming, set the country/region.
2. Connect the remote controller to the internet via Wi-Fi. After connecting, tap "Next" to continue and select the time zone, date, and time.
3. Log in with your DJI account. If you do not have an account, create a DJI account and log in.
4. Tap "Activate" on the activation page.
5. After activating, please select if you would like to join the Smart Controller Improvement Project. The project helps to improve the user experience by sending diagnostic and usage data automatically every day. No personal data will be collected by DJI.
6. The remote controller will check for firmware updates. If a firmware update is available, you will be prompted to download the latest version.



Please check the internet connection if the activation fails. If the internet connection is normal, please try to activate the remote controller again. Contact DJI if the activation continues to fail.

## Linking the Smart Controller

When the Smart Controller is purchased together with an aircraft, the remote controller has already been linked to the aircraft, and they can be directly used after activating the remote controller and aircraft. If the Smart Controller and the aircraft were purchased separately, follow the steps below to link the remote controller to the aircraft.

### Method 1: Using Smart Controller Buttons

1. Power on the remote controller and the aircraft.
2. Press the customizable button C1, C2, and Record button simultaneously. The status LED blinks blue and the controller beeps twice to indicate the linking has started.
3. Press the linking button on the aircraft. The remote controller's status LED will be solid green if the linking is successful.

### Method 2: Using DJI GO 4 / DJI Pilot

1. Power on the remote controller and the aircraft. Tap "Go" on the homepage and log in using a DJI account.
2. Tap "Enter Device", select "Connect to the aircraft", and follow the prompts to start linking.
3. Select "Enter the Camera View" and tap  in camera view. Scroll to the bottom, tap "Remote Controller Linking" and tap "OK" to confirm.
4. The status LED blinks blue and the remote controller beeps twice to indicate the linking has started.
5. Press the linking button on the aircraft. The remote controller's status LED will be solid green if the linking is successful.

### Method 3: Using Quick Settings

1. Power on the remote controller and the aircraft.
2. Swipe down from the top of the screen to open Quick Settings. Tap  to start linking.
3. The status LED blinks blue and the remote controller beeps twice to indicate the linking has started.
4. Press the linking button on the aircraft. The remote controller's status LED will be solid green if the linking is successful.



- Make sure the remote controller is within 1.6 ft (0.5 m) of the aircraft during linking.
  - Make sure the remote controller is connected to the internet when logging in using a DJI account.
- 

## Controlling the Aircraft

The control sticks control the aircraft's orientation (yaw), forward and backward movement (pitch), altitude (throttle), and left and right movement (roll). The control stick mode determines the function of each control stick. Three preprogrammed modes (Mode 1, Mode 2, and Mode 3) are available and custom modes can be configured in DJI GO 4 / DJI Pilot. The default mode is Mode 2.

In each of the three pre-programmed modes, the aircraft hovers in place at a constant orientation when both sticks are centered. See the figures below to see the function of each control stick in the three preprogrammed modes.

Mode 1

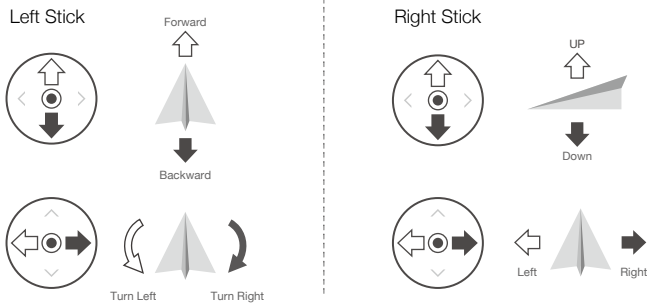

Mode 2

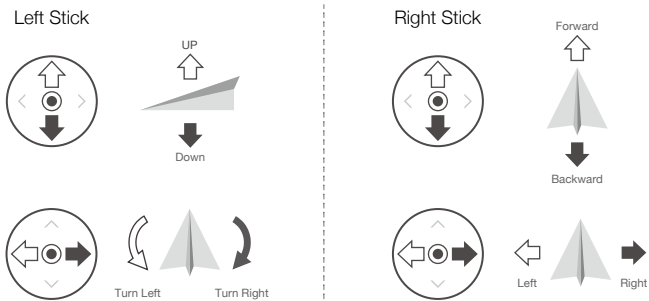



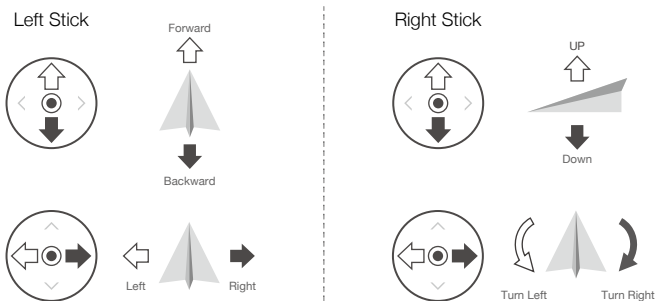



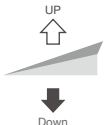

Mode 3

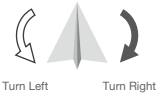

The figure below explains how to use each control stick. Mode 2 has been used as an example.

-  Center position: Control sticks are centered.
- Moving the control stick: Control sticks are pushed away from the center.

Control Stick Mode 2	Aircraft	Remarks
<p>Left Stick</p> 		<p>Moving the left stick up or down changes the aircraft's altitude. Push the stick up to ascend and down to descend. The more the stick is pushed away from the center position, the faster the aircraft changes altitude. Push the stick gently to prevent sudden and unexpected changes in altitude.</p>
<p>Left Stick</p> 		<p>Moving the left stick to the left or right controls the orientation of the aircraft. Push the stick left to rotate the aircraft counter-clockwise and right to rotate the aircraft clockwise. The more the stick is pushed away from the center position, the faster the aircraft rotates.</p>
<p>Right Stick</p> 		<p>Moving the right stick up and down changes the aircraft's pitch. Push the stick up to fly forward and down to fly backward. The more the stick is pushed away from the center position, the faster the aircraft moves.</p>
<p>Right Stick</p> 		<p>Moving the right stick to the left or right changes the aircraft's roll. Push the stick left to fly left and right to fly right. The more the stick is pushed away from the center position, the faster the aircraft moves.</p>

-  • Keep the remote controller away from magnetic materials to avoid it being affected by magnetic interference.
- To avoid damage, it is recommended that the control sticks are removed and stored in the storage slot on the remote controller during transportation or storage.

## Flight Mode Switch

Toggle the switch to select the flight mode. Choose between T-mode, P-mode, and S-mode.

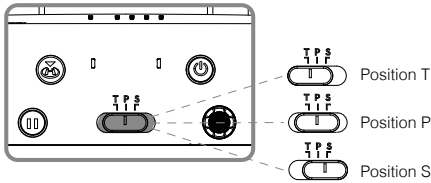



Position	Flight Mode
T	T-mode (Tripod)
P	P-mode (Positioning)
S	S-mode (Sport)

**T-mode (Tripod):** The aircraft utilizes GPS and vision systems to locate itself, stabilize, and navigate between obstacles. In this mode, the maximum flight speed is limited to 2.2 mph (3.6 kph). The responsiveness to stick movements is also reduced for smoother, more controlled movement.

**P-mode (Positioning):** P-mode works best when the GPS signal is strong. The aircraft utilizes GPS, Vision Systems, and an Infrared Sensing System to stabilize, avoid obstacles, and track moving subjects. Advanced features such as TapFly and ActiveTrack are available in this mode.

**S-mode (Sport):** The handling gain values of the aircraft are adjusted to enhance aircraft maneuverability. Note that Vision Systems are disabled in this mode.

Regardless of the position the switch is in on the remote controller, the aircraft begins in P-mode by default. To switch flight modes, first go to camera view in DJI GO 4 / DJI Pilot, tap  and enable "Multiple Flight Modes". After enabling multiple flight modes, toggle the switch to P and then to S or T to switch flight modes.

 Refer to the flight modes section in the aircraft's user manual for more information about flight mode features for different aircraft types.

## RTH Button

Press and hold the RTH button to start Return to Home (RTH) and the aircraft will return to the last recorded Home Point. Press the button again to cancel RTH and regain control of the aircraft. Refer to the Return to Home section in the aircraft's user manual for more information about RTH.

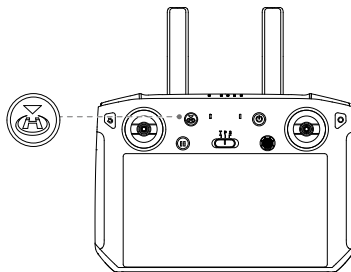

## Customizable Buttons

There are three customizable buttons on the controller: C1, C2, and the Confirm button. When the remote controller is not linked to an aircraft, press the Confirm button to confirm a selection. When the remote controller is linked to an aircraft, the button cannot be used to confirm a selection. However, the function of the button when linked to an aircraft can be customized in DJI GO 4 / DJI Pilot.

The functions of the C1 and C2 buttons are set in DJI GO 4 / DJI Pilot. The default configuration for the C1 button is center focus and the default configuration for the C2 button is playback.

## Optimal Transmission Range

The optimal transmission range of the Smart Controller is shown below:

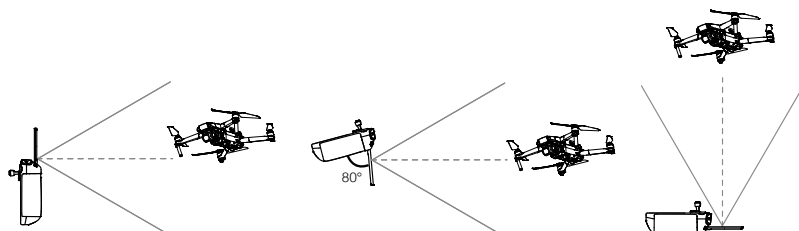

Make sure the antennas are facing towards the aircraft. When the angle between the antennas and the back of the Smart Controller is 80° or 180°, the connection between the remote controller and the aircraft can reach its optimal performance.

Note that the illustrations above do not reflect the actual distances between the user and aircraft and are for reference only.

---

 DJI GO 4 / DJI Pilot will warn the user when the transmission signal is weak. Adjust the antennas to make sure that the aircraft is within the optimal transmission range.

---

## Operating the Camera

Shoot videos and photos with the Focus/Shutter button and Record button on the remote controller.

1. Focus/Shutter Button

Press to take a photo. If Burst mode is selected, multiple photos will be taken if the button is continuously pressed.

2. Record Button

Press once to start recording video and press again to stop.

3. Camera Settings Dial

Mavic 2 Pro: Turn the dial to adjust the exposure compensation (when in Program mode), aperture (when in Aperture Priority and Manual mode), or shutter (when in Shutter Priority mode).

Mavic 2 Zoom/ Mavic 2 Enterprise: Turn to adjust the zoom of the Mavic 2 Zoom camera.

Mavic 2 Enterprise Dual: Turn the dial to adjust the exposure compensation.

## Dual Remote Controller Mode

DJI Smart Controller supports Dual Remote Controller Mode when using with the Mavic 2 Pro/Zoom, which allows two remote controllers to connect to the same aircraft.

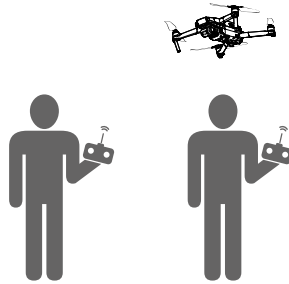

Both the Primary remote controller and the Secondary remote controller can control the orientation of the aircraft and the movement of the gimbal and camera operation.

Please note the different operations of the Primary and Secondary remote controller listed below.

### 1. Gimbal Dial

Both the Primary remote controller and the Secondary remote controller can control the gimbal dial, but the Primary remote controller has priority. For example, the Secondary remote controller is unable to control the gimbal dial when the Primary remote controller is using the gimbal dial. After the Primary remote controller has stopped controlling the gimbal dial for two seconds or more, the Secondary remote controller can control the gimbal dial.

### 2. Control Stick

Both the Primary remote controller and the Secondary remote controller can control the orientation of the aircraft using control sticks. The Primary remote controller has priority. The Secondary remote controller is unable to control the aircraft's orientation when the Primary remote controller is operating the control sticks. After the control sticks are idle for two seconds or more, the Secondary remote controller can control the aircraft's orientation.

If the control sticks on the Primary remote controller are pushed down and inward, the motors of the aircraft stop. If the same action is performed on the Secondary remote controller, however, the aircraft does not respond.

The control sticks on the Primary remote controller need to be released so that the Secondary remote controller can control the aircraft.

### 3. Flight Mode Switch

The flight mode can only be switched on the Primary remote controller. The Flight Mode Switch is disabled on the Secondary remote controller.

### 4. DJI GO 4 Settings

The display and parameter settings for the Primary and Secondary remote controllers in DJI GO 4 are the same. The Secondary remote controller can only configure the flight controller, vision system, video transmission, and Intelligent Flight Battery. Display and parameter settings for the Primary and Secondary remote controllers are the same in DJI GO 4.

# Display Interface

## Homepage

The screen displays the homepage when the Smart Controller is powered on.

Example: Mavic 2 Pro

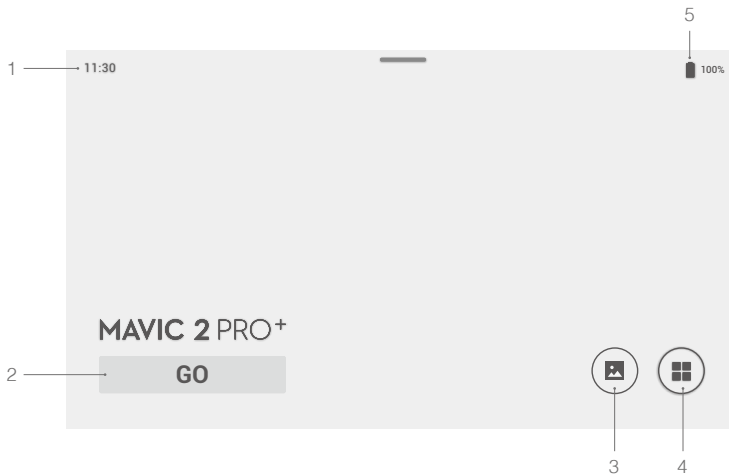

### 1 Time

Displays local time.

### 2 DJI GO 4 / DJI Pilot

Tap to enter DJI GO 4 / DJI Pilot. The button is blue if the remote controller is linked to the aircraft. Users can tap to enter camera view after logging in using a DJI account. If the remote controller is not linked to the aircraft, tap, and log in using a DJI account. Select "Enter Device" and follow the prompts to enter camera view.

### 3 Gallery

Tap to check stored images and videos.

### 4 App Center

Tap to check all applications including DJI GO 4 / DJI Pilot, Settings, File Manager, and any third-party apps that users have downloaded and installed. Refer to the App Center section for more information.

### 5 Battery Level

Displays the battery level of the remote controller.



Navigate on the remote controller by using the 5D button, the control sticks, or touching the screen. Confirm a selection by pressing the 5D button or touching the screen. Refer to the Control Stick Navigation section for more information.



## App Center

Tap  to enter App Center. Users can find default system apps and third-party apps that have been downloaded.

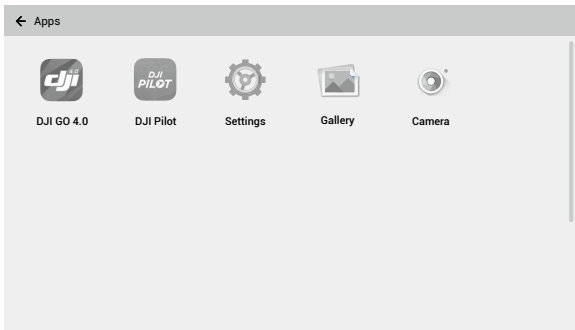

The App Center is subject to change in future

Press the icon to enter the app.

To move an app, hold the icon and move the app to where you wish to place it. To delete the app, hold the icon and drag it to the top of this page to remove it. Note that default system apps cannot be deleted.

Press Settings to be able to configure settings such as button combinations, control stick navigation, date & time, languages, Wi-Fi, and Bluetooth.







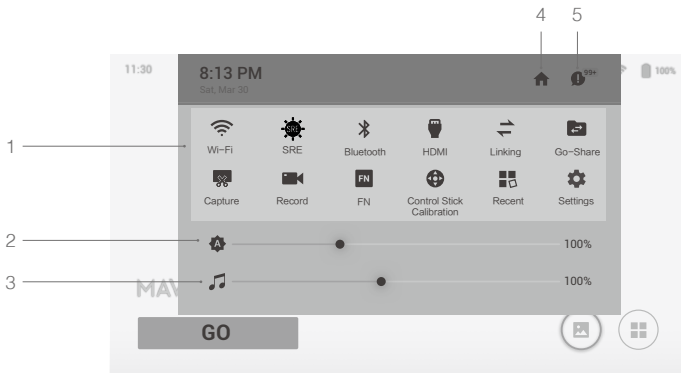





 DJI bears no responsibility for the safe use of or compatibility support for third-party apps. If a third-party app is affecting the performance of the Smart Controller, try to delete the third-party apps or reset the Smart Controller to factory settings. To reset the Smart Controller to factory settings, go to Factory Data Reset under Settings.

## Quick Settings

Swipe down from the top of the screen to open Quick Settings.



1 Tap an icon to enable or disable the corresponding function. Hold the icon to enter the settings of the function (if available).

-  : Tap to enable or disable Wi-Fi. Hold to enter settings and connect to or add a Wi-Fi network.
-  : Tap to enable or disable SRE mode. Hold to enter settings and select an SRE mode.
-  : Tap to enable or disable Bluetooth. Hold to enter settings and connect with nearby Bluetooth devices.
-  : Tap to enable or disable the HDMI connection. Hold to enter settings and adjust HDMI resolution, rotation, output mode, and screen zoom.
-  : Tap to start linking the remote controller to an aircraft.
-  : Tap to activate DJI GO Share. Hold to enter settings and set a GO Share Hotspot. Refer to the DJI GO Share section for more information.
-  : Tap to screenshot the screen.
-  : Tap to start recording the screen. While recording, the screen displays the recording time. Tap "Stop" to stop recording.
-  : Tap or hold to check the button combinations.
-  : Tap to calibrate the sticks and wheels.
-  : Tap to check recently opened apps.
-  : Tap or hold to enter settings.

## 2 Adjusting Brightness

Slide the bar to adjust brightness. The icon  means auto brightness. Tap this icon or slide the bar, and the icon will turn to  to switch it to manual brightness mode.

## 3 Adjusting Volume

Slide the bar to adjust the volume. Tap  to mute the volume.

## 4 Homepage

 : Tap to go back to the homepage.

## 5 Notifications

 : Tap to check system notifications.

- 
-  • SRE (Sunlight Readable Enhancement) allows users to bump up the highlights or shadows of an image individually or together. This helps users see particular areas of the screen more clearly when sunlight is strong.
  - Quick Settings vary depending on the aircraft model linked and the firmware version of the Smart Controller.
- 

## DJI GO 4 App / DJI Pilot



To enter DJI GO 4 / DJI Pilot, tap "Go" on the homepage or tap  on the homepage, then tap DJI GO 4 / DJI Pilot. In DJI GO 4 / DJI Pilot, you can check the flight status and set flight and camera parameters. Since the Smart Controller is compatible with multiple aircraft models, and the interface of DJI GO 4 / DJI Pilot may change based on the aircraft model, refer to the DJI GO 4 / DJI Pilot app section in the aircraft's user manual for more information.

# Appendix



## Changing Storage Locations for Images and Videos

After linking, you can use DJI GO 4 / DJI Pilot to select to store images and videos on the aircraft. Users can also use DJI GO 4 / DJI Pilot to select to store images and videos to the Smart Controller or on the microSD card in the Smart Controller.

### Auto Sync HD Photos:

Power on the remote controller and the aircraft, and make sure they are linked. Run DJI GO 4 / DJI Pilot, and enter the camera view. Tap  >  and enable "Auto Sync HD Photos". All images will be stored in high resolution to the microSD card in the remote controller at the same time when the microSD card in the aircraft stores the images.

### Store to Smart Controller:

Power on the remote controller and the aircraft, and make sure they are linked. Run DJI GO 4 / DJI Pilot, and enter camera view. Tap  >  :

To cache images and videos to the remote controller, enable "Cache Locally When Recording".

To store images and videos to the microSD card in the remote controller, enable "Download Footage to External SD Card".

When "Download Footage to External SD Card" is enabled, all the selected images will be downloaded to the remote controller's microSD card when downloading the images to the remote controller in playback.

- 
-  • The "Cache Locally When Recording" and "Download Footage to External SD Card" are disabled by default.
  - To enable "Download Footage to External SD Card", make sure a microSD card is inserted into the remote controller.
- 

## Control Stick Navigation

Tap Control Stick Navigation in Settings. Users can enable or disable the control sticks and 5D button to navigate on the remote controller. Control Stick Navigation is not available when the remote controller is linked to an aircraft, even if it is enabled beforehand.

**Control Sticks:** Move up, down, right, or left to navigate. It is not possible to confirm a selection with the control sticks.

**5D Button:** Push up, down, right, or left to navigate. Press to confirm a selection.

- 
-  As the control sticks and 5D button may not be compatible with third-party apps, it is recommended to use the touchscreen to navigate when using third-party apps.
- 

## DJI GO Share (only available when using DJI GO 4)

The videos and images downloaded to the Smart Controller from DJI GO 4 can be wirelessly transferred to other smart devices. Follow the steps below to use DJI GO Share.

1. Power on the remote controller and swipe down from the top of the screen to open Quick Settings. Tap  and a QR code will appear.

2. Run DJI GO 4 on your smart device and scan the QR code using DJI GO 4.
3. Wait until the remote controller and the smart device are successfully connected. After connecting, you can check all the images and videos downloaded to the remote controller on your smart device.
4. Select the images and videos you want to share and tap "Download" to download them to your smart device.

 Only images and videos cached or downloaded to your remote controller in playback in DJI GO 4 can be shared using DJI GO Share.

## Status LED and Battery Level Indicators Description

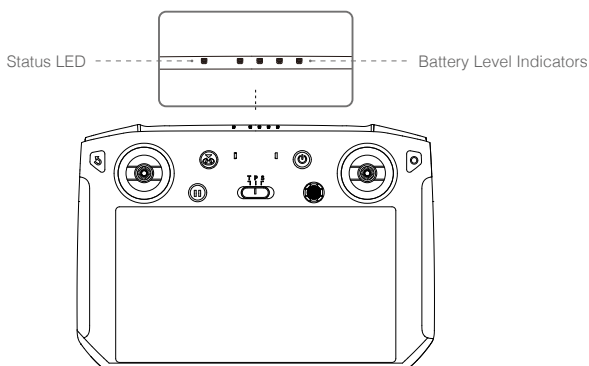

The battery level indicators displays the battery level of the controller. The status LED displays the linking status and warnings for control stick, low battery level, and high temperature.

Status LED	Description
Solid Red	The remote controller is not linked to an aircraft.
Solid Green	The remote controller is linked to an aircraft.
Blinks Blue	The remote controller is linking to an aircraft.
Blinks Red	The temperature of the remote controller is too high or the battery level of the aircraft is low.
Blinks Yellow	The battery level of the remote controller is low.
Blinks Cyan	The control sticks are not centered.

Battery Level Indicators				Battery Level
				75%~100%
				50%~75%
				25%~50%
				0%~25%

## Smart Controller Warning Sounds



In certain scenarios that require a user warning, the Smart Controller will do so by vibrating and/or beeping. When the controller beeps and the status LED is solid green, this error may be related to the aircraft or flight status, and a warning will appear in DJI GO 4 / DJI Pilot. If this error is related to the Smart Controller, the controller's screen will display a warning or alert.

To disable the beeping, power on the remote controller, select "Sound" in Settings, and turn off "Notification volume".

## System Update

### Method 1: Wireless Update

Make sure the remote controller is connected to the internet while updating.

1. Power on the remote controller. Tap  and then . Scroll to the bottom of the page and tap "System Update".
2. Tap "Check for Updates" to check the firmware. A prompt will appear if a firmware update is available.
3. Follow the prompts to finish the update.
4. The remote controller automatically restarts after the update is finished.

### Method 2: DJI Assistant 2

1. Make sure the remote controller is powered off, and then connect the remote controller to a computer using a USB 3.0 USB-C cable.
2. Power on the remote controller.
3. Launch DJI Assistant 2, and log in using a DJI account.
4. Click the Smart Controller icon, and then "Firmware Update".
5. Select and confirm the firmware version you want to update.
6. DJI Assistant 2 will download and update the firmware automatically.
7. The remote controller will restart after update.



- Make sure the remote controller has more than 50% power before updating.
- DO NOT disconnect the USB-C cable during the update.
- Make sure the remote controller or the computer is connected to the internet during the update.
- The update takes approximately 15 minutes.

## Button Combinations

Some frequently-used features can be activated by using button combinations. To use button combinations, hold the back button and then press the other button.

### Checking the available button combinations

Hold the Back button until the controller vibrates to check button combinations:

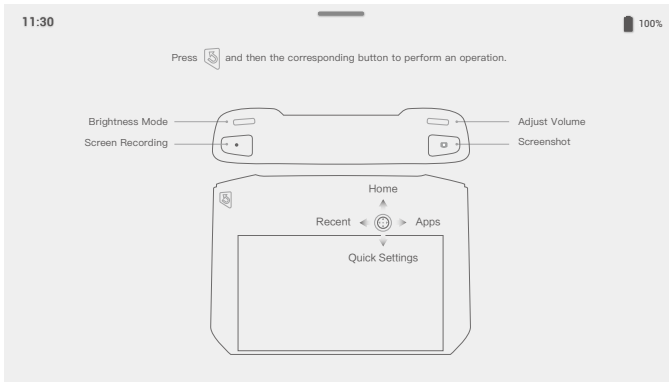

Button Combinations

### Using Button Combinations

The functions of the button combinations cannot be changed. The following table displays the function of each button combination.

Button Combinations	Description
Function Button + Right Wheel	Adjust the system volume
Function Button + Left Wheel	Adjust the screen brightness
Function Button + Record Button	Record the screen
Function Button + Focus/Shutter Button	Screenshot the screen
Function Button + 5D Button (up)	Return to Homepage
Function Button + 5D Button (down)	Open Quick Settings
Function Button + 5D Button (left)	Check recently opened apps
Function Button + 5D Button (right)	Open App Center

### Calibrating the Compass

After the remote controller is used in places with electro-magnetic interference, the compass may need to be calibrated. A warning prompt will appear if the remote controller's compass requires calibration. Tap the warning pop-up to start calibrating. In other cases, follow the steps below to calibrate your remote controller.

1. Enter the App Center, tap , and scroll down and tap Compass.
2. Follow the diagram on the screen to calibrate your remote controller.
3. The user will receive a prompt when the calibration is successful.

## Blocking Third-party Notifications

To ensure safe flight, we recommend to disable third-party notifications before each flight. Follow the steps below to disable third-party notifications.

1. Enter the App Center, tap , and scroll down and tap Notifications.
2. Enable "Aerial Photography Do Not Disturb Mode".

## HDMI

A monitor can display the remote controller's interface by connecting the remote controller to a monitor using a HDMI cable. Follow the steps below to enable the HDMI connection.

1. Swipe down from the top of the screen to open Quick Settings.
2. Follow the diagram on the screen to calibrate your remote controller. Tap HDMI to enable or disable the HDMI connection. Hold to enter settings and adjust HDMI resolution, rotation, output mode, and screen zoom.

## After-sales Information

Please visit <http://www.dji.com/support> for more information about after-sales service and warranty policies.

# Specifications

<b>OcuSync 2.0</b>	
Operation Frequency Range	2.400-2.4835 GHz; 5.725-5.850 GHz*
Max Transmission Distance (Unobstructed, free of interference)	2.400-2.4835 GHz: 8 km (FCC); 4 km (CE); 4 km (SRRC); 4 km (MIC) 5.725-5.850 GHz: 8 km (FCC) : 2 km (CE) : 5 km (SRRC)
Transmitter Power (EIRP)	2.400-2.4835 GHz: 25.5 dBm (FCC); 18.5 dBm (CE); 19 dBm (SRRC); 18.5 dBm (MIC) 5.725-5.850 GHz: 25.5 dBm (FCC); 12.5 dBm (CE); 18.5 dBm (SRRC)
<b>Wi-Fi</b>	
Protocol	Wi-Fi Direct, Wi-Fi Display, 802.11a/g/n/ac Wi-Fi with 2x2 MIMO is supported
Operation Frequency Range	2.400-2.4835 GHz; 5.150-5.250 GHz*; 5.725-5.850 GHz*
Transmitter Power (EIRP)	2.400-2.4835 GHz: 21.5 dBm (FCC); 18.5 dBm (CE); 18.5 dBm (SRRC); 20.5 dBm (MIC) 5.150-5.250 GHz: 19 dBm (FCC); 19 dBm (CE); 19 dBm (SRRC); 19dBm (MIC) 5.725-5.850 GHz: 21 dBm (FCC); 13 dBm (CE); 21 dBm (SRRC)
<b>Bluetooth</b>	
Protocol	Bluetooth 4.2
Operation Frequency Range	2.400-2.4835 GHz
Transmitter Power (EIRP)	4 dBm (FCC); 4 dBm (CE) 4 dBm (SRRC); 4 dBm (MIC)
<b>General</b>	
Battery	18650 Li-ion (5000 mAh @ 7.2 V)
Charge Type	Supports USB power adapters rated 12 V/2 A
Rated Power	15 W
Storage Capacity	Rom: 16 GB + scalable (microSD**)
Charge Time	2 hours (Using a USB power adapter rated 12 V/2 A)
Working Time	2.5 hours
Video Output Port	HDMI Port
Power Supply Current/ Voltage (USB-A port)	5 V/ 900 mA
Operation Temperature Range	4° to 104° F (-20° to 40° C) Less than one month: -22° to 140° F (-30° to 60° C) One month to three months: -22° to 113° F (-30° to 45° C) Three months to six months: -22° to 95° F (-30° to 35° C) More than six months: -22° to 77° F (-30° to 25° C)
Storage Temperature Range	



Charging Temperature Range	5° to 40° C (41° to 104° F)
Supported Aircraft Models***	Mavic 2 Pro, Mavic 2 Zoom, Mavic 2 Enterprise, Mavic 2 Enterprise Dual
Recommended microSD Cards	Sandisk Extreme 32GB UHS-3 microSDHC Sandisk Extreme 64GB UHS-3 microSDXC Panasonic 32GB UHS-3 microSDHC Panasonic 64GB UHS-3 microSDXC Samsung PRO 32GB UHS-3 microSDHC Samsung PRO 64GB UHS-3 microSDXC Samsung PRO 128GB UHS-3 microSDXC
GNSS	GPS+GLONASS
Dimensions	177.5 × 121.3 × 40 mm (antennas folded, and the control sticks unmounted) 177.5 × 181 × 60 mm (antennas unfolded, and the control sticks mounted)
Weight	Approx. 630 g

\* Local regulations in some countries prohibit the use of the 5.8 GHz and 5.2 GHz frequencies and in some regions the 5.2 GHz frequency is only allowed for indoor use.

\*\* The Smart Controller supports microSD cards with a maximum storage capacity of 128 GB.

\*\*\* The Smart Controller will support more DJI aircraft in future. Please visit the official website for the latest information.

DJI Support

<http://www.dji.com/support>

This content is subject to change.

**Download the latest version from**

<http://www.dji.com/dji-smart-controller>

If you have any questions about this document, please contact DJI by sending a message to [DocSupport@dji.com](mailto:DocSupport@dji.com).

© 2019 DJI All Rights Reserved.